

SFH 3100 F

Radial Mini Sidelooker

Silicon NPN Phototransistor with Daylight - Cutoff Filter



Applications

- Industrial Automation (Machine Controls, Light Barriers, Vision Controls)

Features:

- Package: black epoxy
- ESD: 2 kV acc. to ANSI/ESDA/JEDEC JS-001 (HBM, Class 2)
- Spectral range of sensitivity: (typ) 850 ... 1100 nm
- Narrow half angle
- Small outline dimensions
- Same package as IRED SFH 4141
- High coupling factor in light barriers with SFH 4141
- Easy identification of SFH 3100 F (black package) and SFH 4141 (clear package)

Ordering Information

Type	Photocurrent $V_{CE} = 5 \text{ V}; \lambda = 950 \text{ nm}; E_e = 0.5 \text{ mW/cm}^2$ I_{PCE}	Ordering Code
SFH 3100 F	400 ... 5000 μA	Q62702P5073
SFH 3100 F-2/3/4	630 ... 3200 μA	Q62702P5475

Only one bin within one packing unit (variation less than 2:1)

Maximum Ratings

$T_A = 25\text{ °C}$

Parameter	Symbol		Values
Operating temperature	T_{op}	min. max.	-40 °C 85 °C
Storage temperature	T_{stg}	min. max.	-40 °C 85 °C
Collector-emitter voltage	V_{CE}	max.	35 V
Collector current	I_C	max.	50 mA
Collector surge current $\tau \leq 10\ \mu\text{s}$	I_{CS}	max.	100 mA
Emitter-collector voltage	V_{EC}	max.	7 V
Total power dissipation	P_{tot}	max.	150 mW
ESD withstand voltage acc. to ANSI/ESDA/JEDEC JS-001 (HBM, Class 2)	V_{ESD}	max.	2 kV

Characteristics

$T_A = 25\text{ °C}$

Parameter	Symbol		Values
Wavelength of max sensitivity	$\lambda_{S\text{ max}}$	typ.	920 nm
Spectral range of sensitivity	$\lambda_{10\%}$	typ.	850 ... 1100 nm
Chip dimensions	L x W	typ.	0.55 x 0.55 mm x mm
Radiant sensitive area	A	typ.	0.11 mm ²
Half angle	φ	typ.	14 °
Dark current	I_{CE0}	typ.	1 nA
$V_{CE} = 20\text{ V}; E = 0$		max.	50 nA
Rise time	t_r	typ.	7 μs
$I_C = 1\text{ mA}; V_{CC} = 5\text{ V}; R_L = 1\text{ k}\Omega$			
Fall time	t_f	typ.	9 μs
$I_C = 1\text{ mA}; V_{CC} = 5\text{ V}; R_L = 1\text{ k}\Omega$			
Collector-emitter saturation voltage ¹⁾	V_{CEsat}	typ.	140 mV
Threefold saturated		max.	400 mV
Capacitance	C_{CE}	typ.	4 pF
$V_{CE} = 5\text{ V}; f = 1\text{ MHz}; E = 0$			
Capacitance	C_{CE}	typ.	7.5 pF
$V_{CE} = 0\text{ V}; f = 1\text{ MHz}; E = 0$			
Thermal resistance junction ambient real	R_{thJA}	max.	280 K / W

Grouping

$T_A = 25\text{ °C}$

Group	Photocurrent	Photocurrent
	$V_{CE} = 5\text{ V}; \lambda = 950\text{ nm}; E_e = 0.5\text{ mW/cm}^2$ min. I_{PCE}	$V_{CE} = 5\text{ V}; \lambda = 950\text{ nm}; E_e = 0.5\text{ mW/cm}^2$ max. I_{PCE}
1	400 μA	800 μA
2	630 μA	1250 μA
3	1000 μA	2000 μA
4	1600 μA	3200 μA
5	2500 μA	5000 μA

Relative Spectral Sensitivity ^{2), 3)}

$S_{rel} = f(\lambda)$

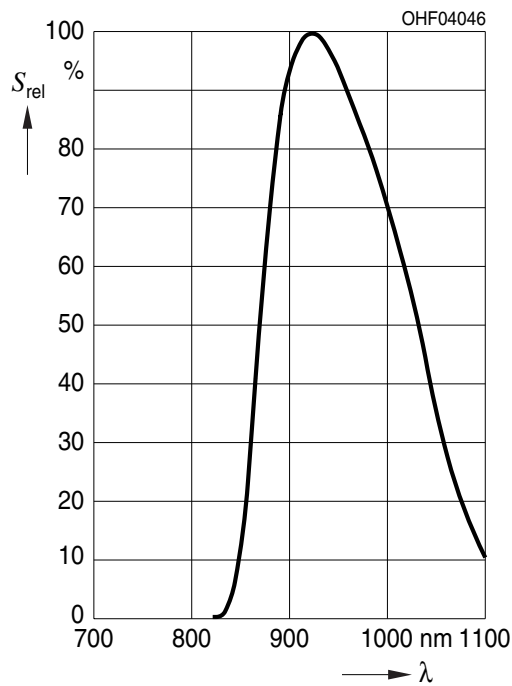

Photocurrent 2), 3)

$I_{PCE} = f(E_e); V_{CE} = 5\text{ V}$

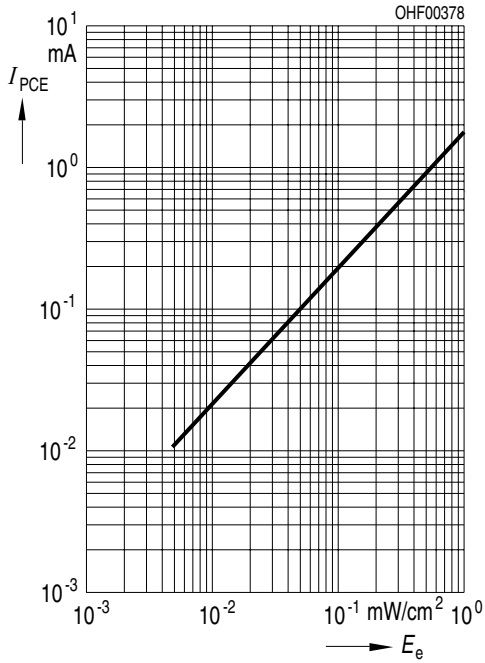

Photocurrent 2), 3)

$I_{PCE} = f(V_{CE}), E_e = \text{Parameter}$

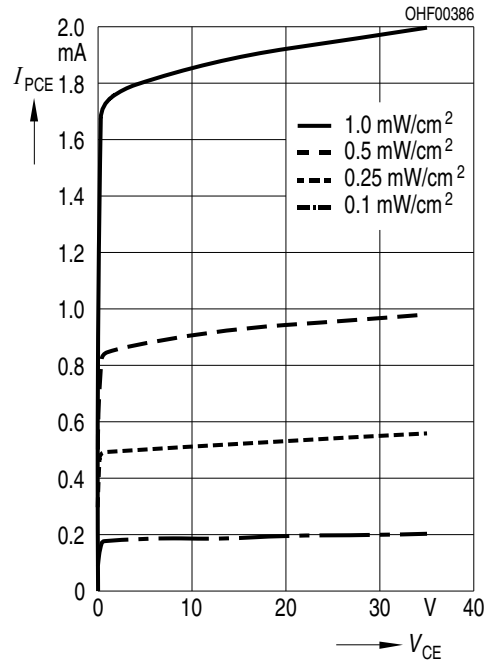

Dark Current 2), 3)

$I_{CEO} = f(V_{CE}); E = 0;$

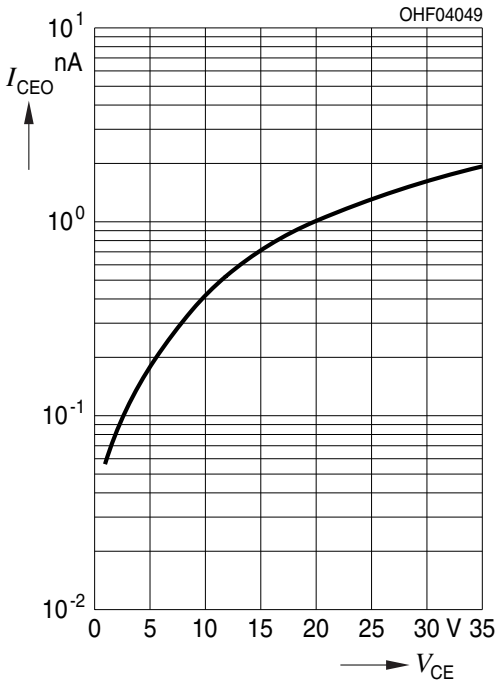

Collector-Emitter Capacitance ^{2), 3)}

$$C_{CE} = f(V_{CE}); f = 1 \text{ MHz}; E = 0 ;$$

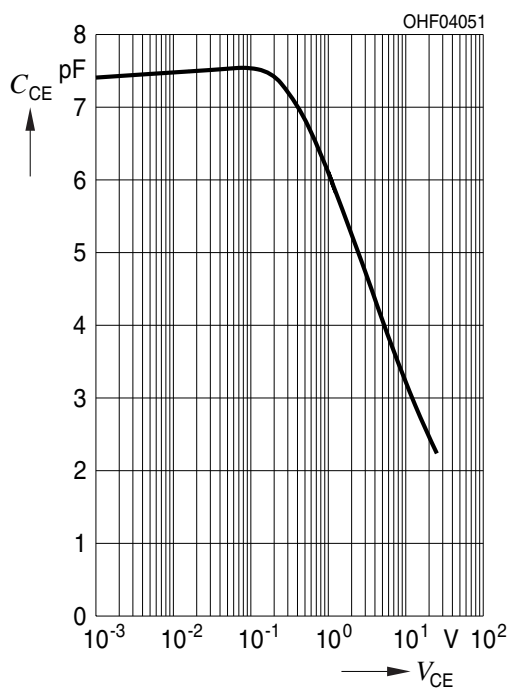

Dark Current ²⁾

$$I_{CEO} = f(T_A); E = 0$$

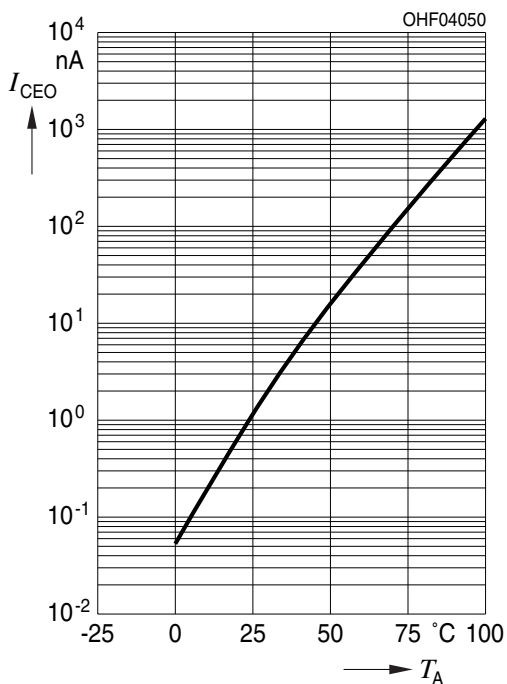

Photocurrent ²⁾

$$I_{PCE,rel} = f(T_A); V_{CE} = 5 \text{ V}$$

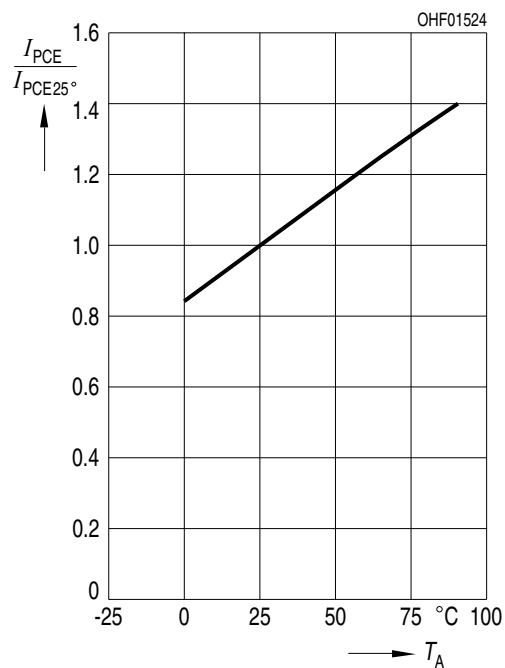

Power Consumption

$$P_{\text{tot}} = f(T_A)$$

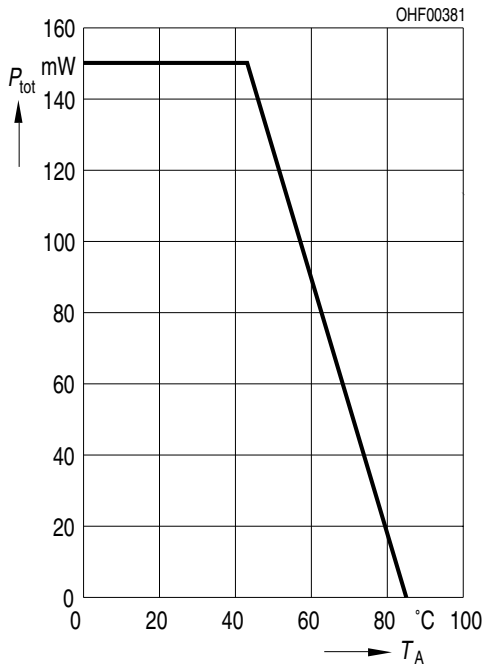

Dimensional Drawing ⁴⁾

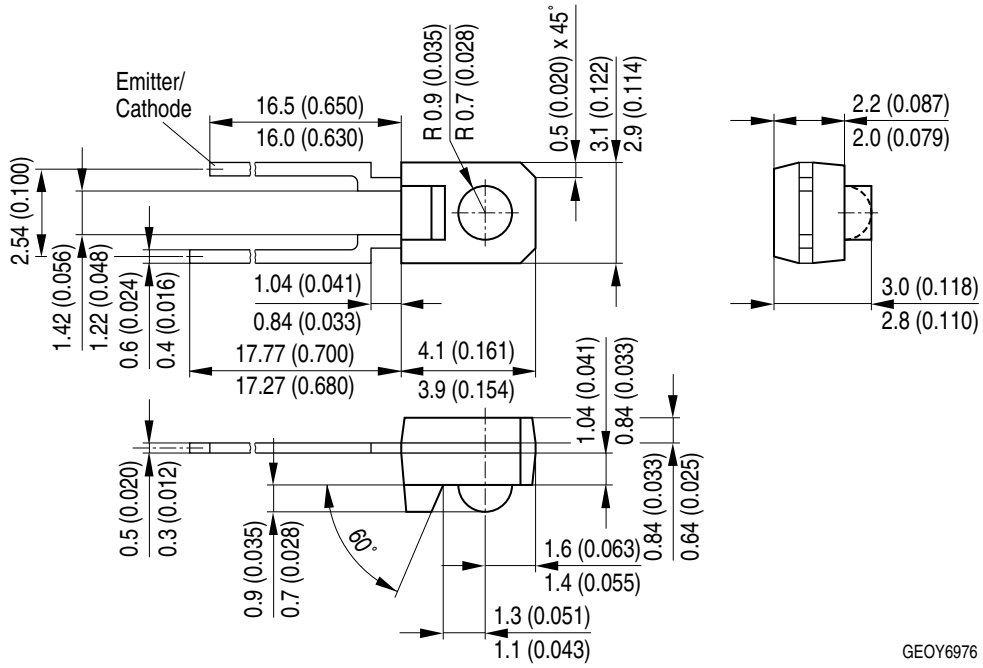

GEOY6976

Approximate Weight: 156.0 mg

Package marking: Collector

Recommended Solder Pad ⁴⁾

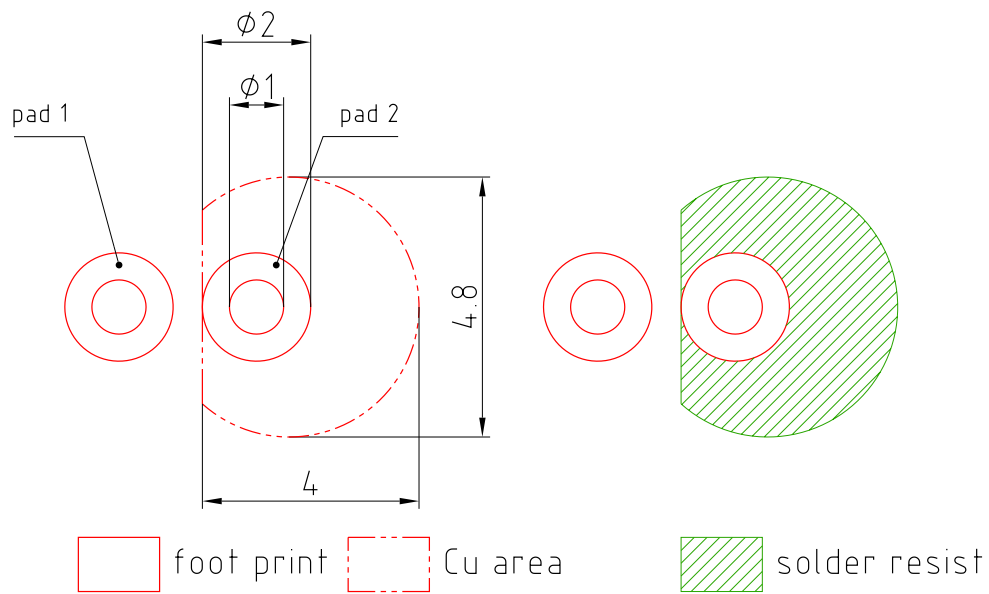

E062.3010.188-01

Pad 1: emitter

TTW Soldering

IEC-61760-1 TTW

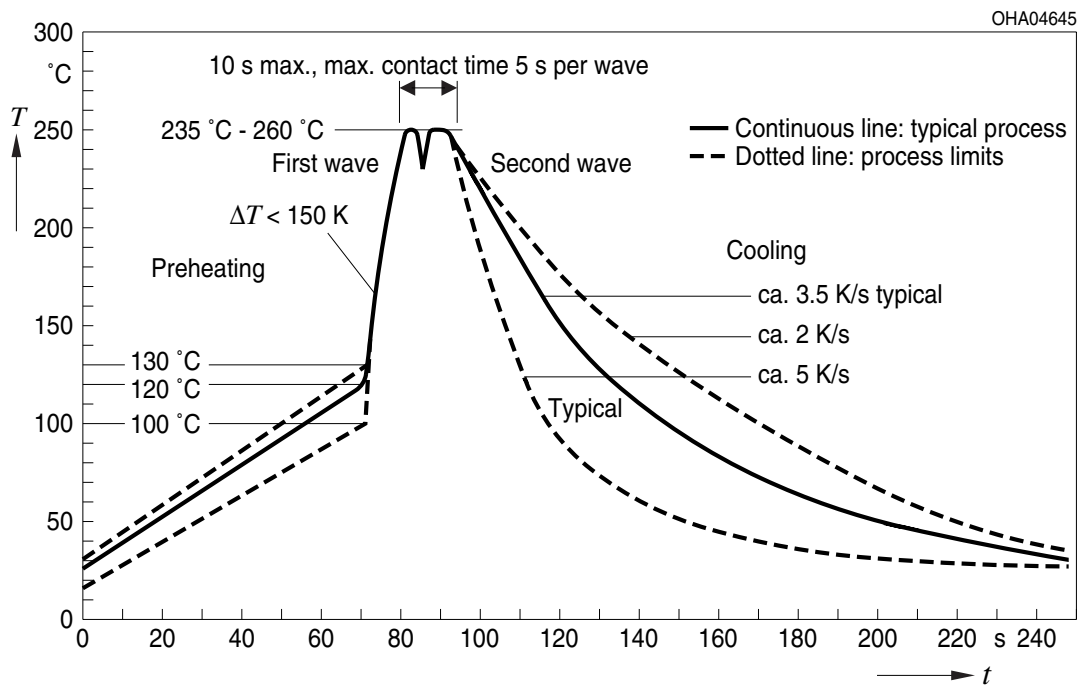

Notes

The evaluation of eye safety occurs according to the standard IEC 62471:2006 (photo biological safety of lamps and lamp systems). Within the risk grouping system of this IEC standard, the device specified in this data sheet falls into the class **exempt group (exposure time 10000 s)**. Under real circumstances (for exposure time, conditions of the eye pupils, observation distance), it is assumed that no endangerment to the eye exists from these devices. As a matter of principle, however, it should be mentioned that intense light sources have a high secondary exposure potential due to their blinding effect. When looking at bright light sources (e.g. headlights), temporary reduction in visual acuity and afterimages can occur, leading to irritation, annoyance, visual impairment, and even accidents, depending on the situation.

Subcomponents of this device contain, in addition to other substances, metal filled materials including silver. Metal filled materials can be affected by environments that contain traces of aggressive substances. Therefore, we recommend that customers minimize device exposure to aggressive substances during storage, production, and use. Devices that showed visible discoloration when tested using the described tests above did show no performance deviations within failure limits during the stated test duration. Respective failure limits are described in the IEC60810.

For further application related informations please visit www.osram-os.com/appnotes

Disclaimer

Disclaimer

Language english will prevail in case of any discrepancies or deviations between the two language wordings.

Attention please!

The information describes the type of component and shall not be considered as assured characteristics. Terms of delivery and rights to change design reserved. Due to technical requirements components may contain dangerous substances.

For information on the types in question please contact our Sales Organization.

If printed or downloaded, please find the latest version in the OSRAM OS Website.

Packing

Please use the recycling operators known to you. We can also help you – get in touch with your nearest sales office.

By agreement we will take packing material back, if it is sorted. You must bear the costs of transport. For packing material that is returned to us unsorted or which we are not obliged to accept, we shall have to invoice you for any costs incurred.

Product safety devices/applications or medical devices/applications

OSRAM OS components are not developed, constructed or tested for the application as safety relevant component or for the application in medical devices.

In case Buyer – or Customer supplied by Buyer– considers using OSRAM OS components in product safety devices/applications or medical devices/applications, Buyer and/or Customer has to inform the local sales partner of OSRAM OS immediately and OSRAM OS and Buyer and /or Customer will analyze and coordinate the customer-specific request between OSRAM OS and Buyer and/or Customer.

Glossary

- 1) **IPCEmin:** I_{PCEmin} is the min. photocurrent of the specified group.
- 2) **Typical Values:** Due to the special conditions of the manufacturing processes of semiconductor devices, the typical data or calculated correlations of technical parameters can only reflect statistical figures. These do not necessarily correspond to the actual parameters of each single product, which could differ from the typical data and calculated correlations or the typical characteristic line. If requested, e.g. because of technical improvements, these typ. data will be changed without any further notice.
- 3) **Testing temperature:** $T_A = 25^\circ\text{C}$
- 4) **Tolerance of Measure:** Unless otherwise noted in drawing, tolerances are specified with ± 0.1 and dimensions are specified in mm.

Published by OSRAM Opto Semiconductors GmbH
Leibnizstraße 4, D-93055 Regensburg
www.osram-os.com © All Rights Reserved.

EU RoHS and China RoHS compliant product



此产品符合欧盟 RoHS 指令的要求；
按照中国的相关法规和标准，不含有毒有害物质或元素。